

BESPOKE GLASS DESIGN AND PRODUCTION SINCE 1978

# Fittings for glass doors and shower enclosures

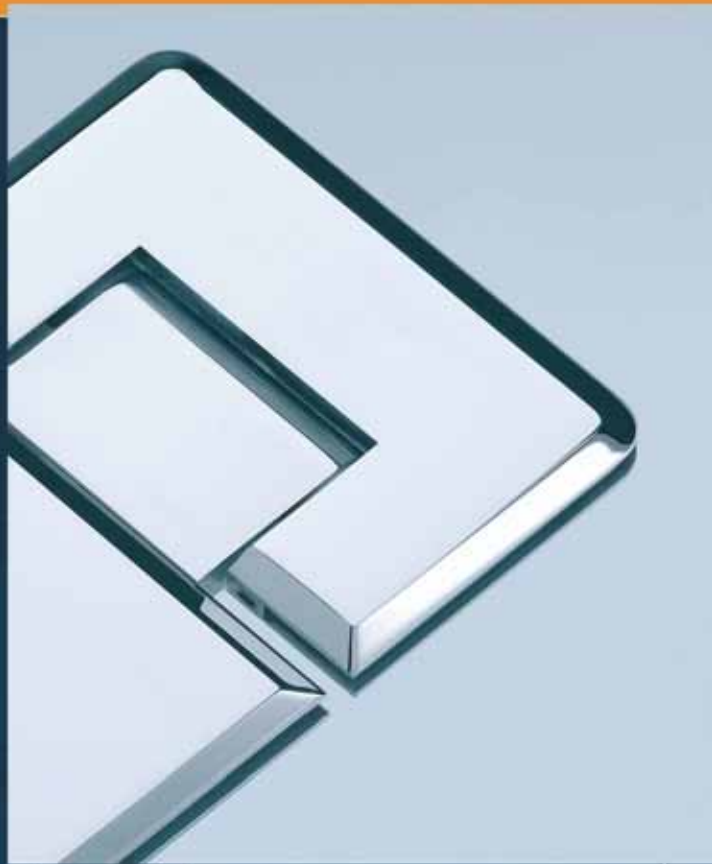

*A range of contemporary shower screens, doors and enclosures custom designed to create a stunning shower surround or designer wet room.*



WWW.GOGLASS.CO.UK

# Frameless Glass Hinges

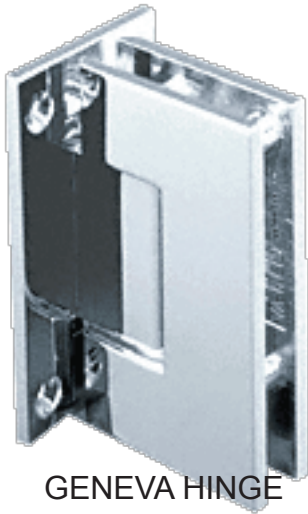

GENEVA HINGE

An economy hinge for smaller glass doors offering 180° action, self centering and available in Polished or Satin Finish with other finishes special order.



VIENNA HINGE

Our most popular hinge offering 180° action, 90° in and 90° out. Self-centering when within 15° of closed position. Suitable for doors up to 914mm wide and 63 kilos in weight. Available in Polished Chrome or Brushed Nickel finish from stock or to order in other finishes.

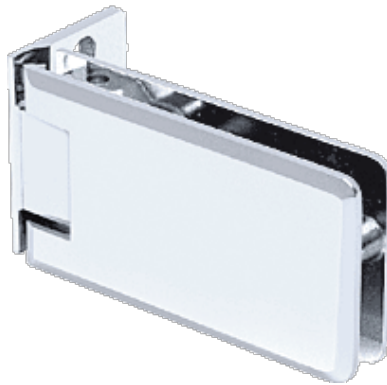
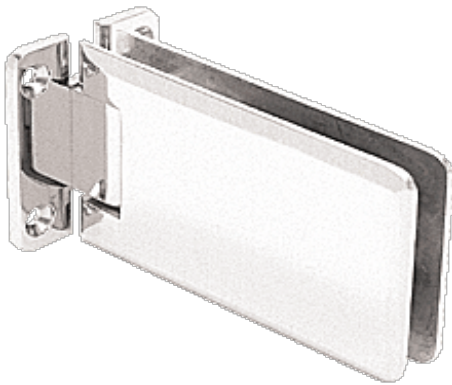

GRANDE HINGE

A Strong rectangular design with a beveled edge, offering 180° action 90° in and 90° out. Suitable for doors up to 864mm wide and 61kg in weight. Available in Polished Chrome or Brushed nickel finish from stock or to order in other finishes.

# Knobs and Handles (Suitable for all glass doors)

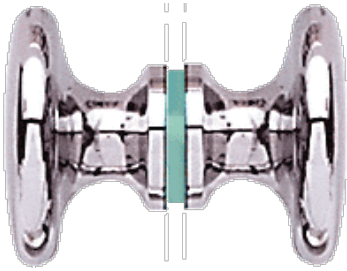

SDK100 Traditional Style Knob  
40mm Dia Polished or Brushed Finish

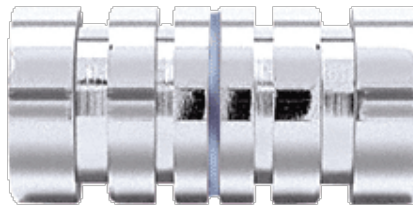

SDK107 Contemporary Style Knob  
25mm Dia Polished or Brushed Finish

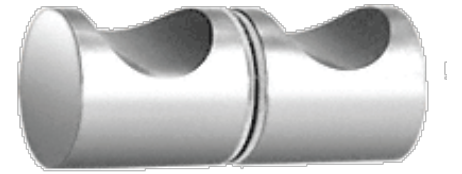

SDK140 Contemporary Style Knob  
25mm Dia Polished or Brushed Finish

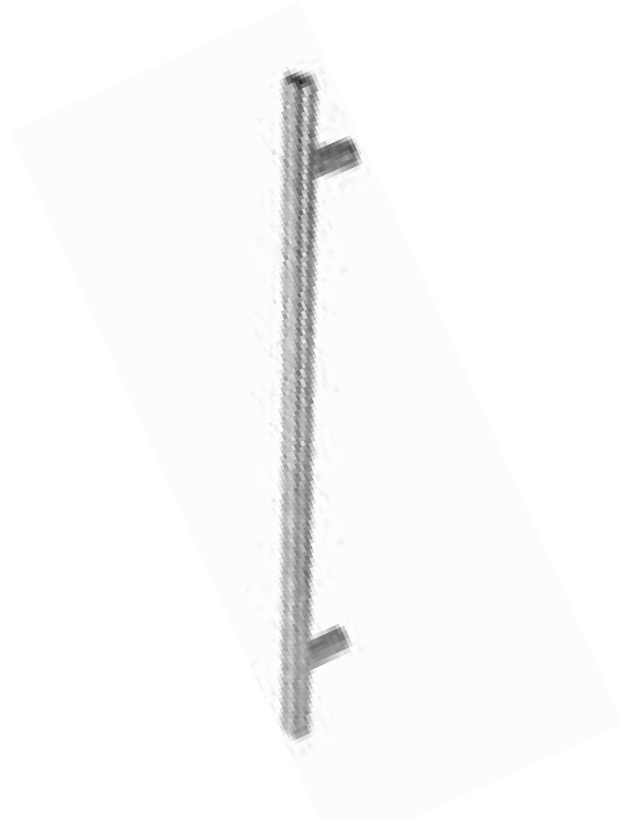

Slimline 12mm Double Sided T Bar Handle  
in 224mm and 448mm Length  
Polished or Brushed Finish



T Bar Handle available in 400, 500, 600,  
800, 1000 and 1200mm Lengths. Dia  
is either 19 or 25mm depending on length  
Polished or Brushed Finish



D Handle available in 350, 600,  
800, and 1200mm Lengths. Dia  
is either 25-38mm depending on length  
Polished or Brushed Finish

# Commercial Glass Door Hardware

Patch Fittings and Floor Closers

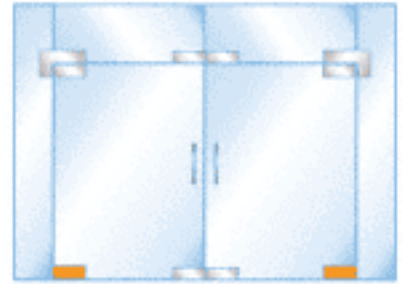
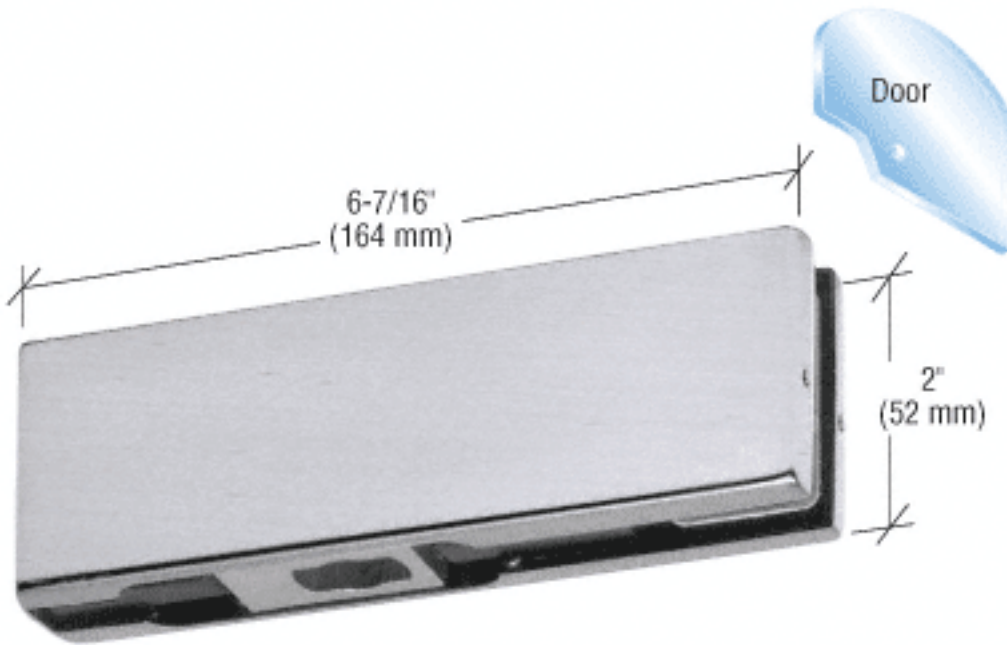

**1NT301 Insert**  
(Included)

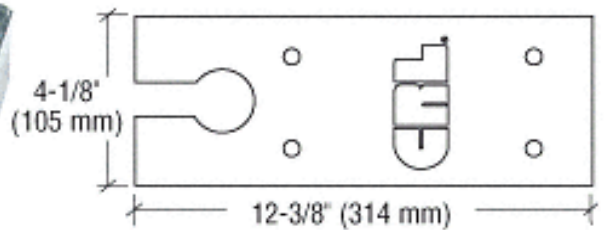
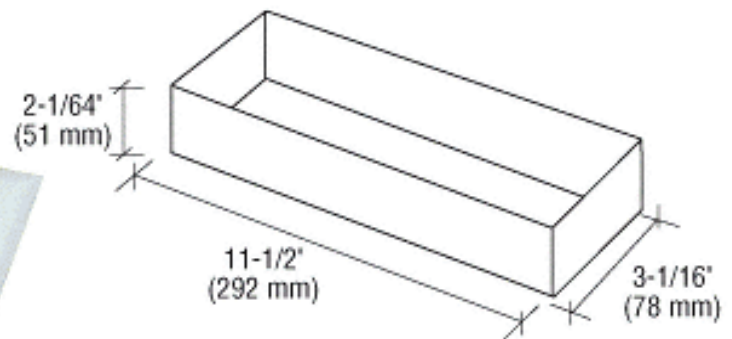
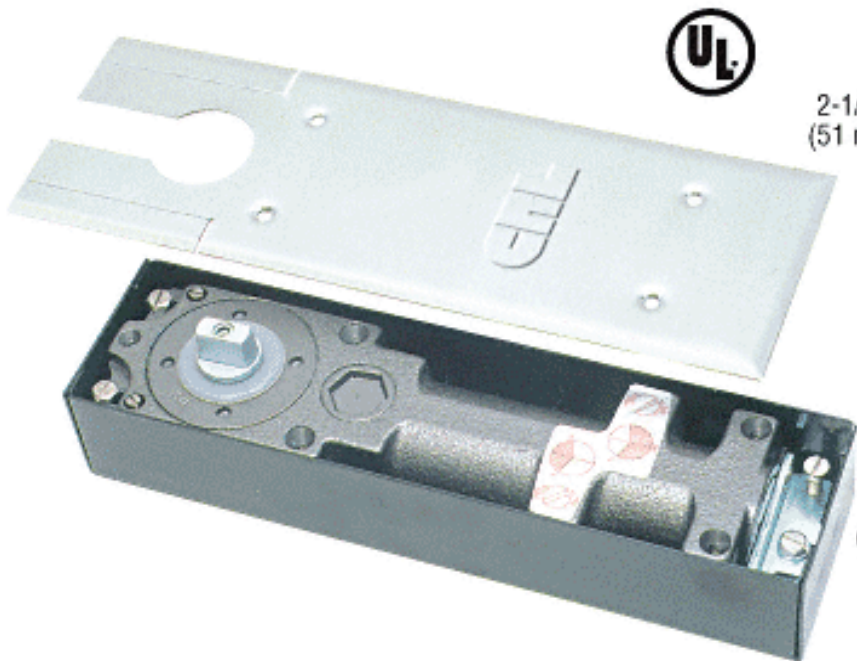

# GLASS CLAMPS

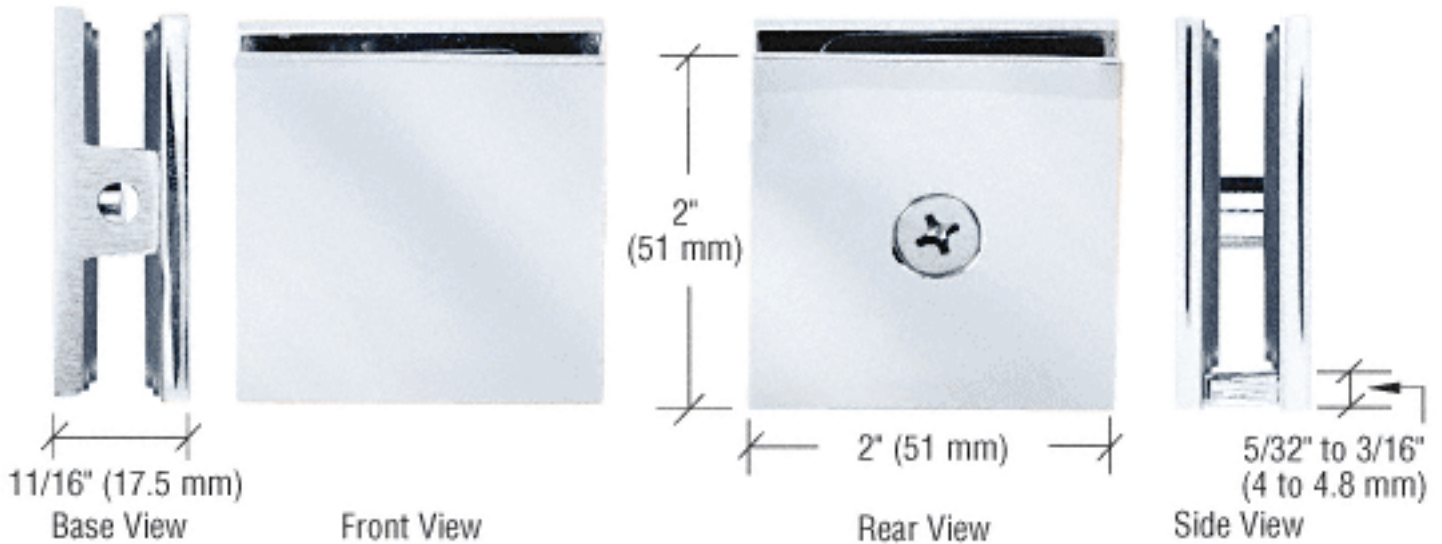

Square glass and wall clamps to fit directly to the wall, ceiling, or floor to secure vertical panels. Also available as  $180^\circ$  or  $90^\circ$  degree fixing. Polished and Satin finish available with other finishes to order.

## Other Fittings for Glass Doors



### SLIDING GLASS DOOR HANDLE

Sliding Glass Door Handle, Inset into the glass door so that the door can slide over the opening. 50mm Diameter in Satin Stainless Finish

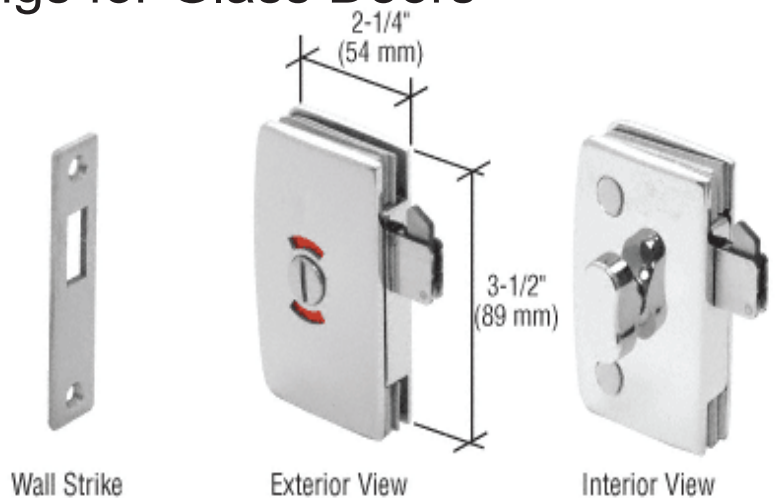

### INDICATOR LOCK

Indicator Lock for bathroom with thumbturn to interior. Suitable for Sliding and hinged glass doors. Available in Polished or Satin finish.



All our products can be found on our comprehensive website at

**WWW.GOGLASS.CO.UK**

Please feel free to browse at your leisure where you will be able to download electronic versions of our new catalogues online.

Go Glass have produced a new range of brochures to show our different products in more detail and show the different applications in which they can be used.

They cover the following :

- Decorative, sandblasted and etched glass.
- Interior glass doors, partitions and screens.
- Frameless glass showers.
- Glass splashbacks and worktops.

For further details of products or to receive a free catalogue, please call in at our office or contact us today.

**address :** 127 Cherry Hinton Road  
Cambridge CB1 7BS

**fax :** 01223 242286

**email :** info@goglass.co.uk

**telephone :** 01223 211041

**web :** www.goglass.co.uk



 ClearShield™

**Go** *glass*  
FLAT GLASS SPECIALISTS SINCE 1978

**GGF**